



Colour Television
Service Manual

CE28MT2-EH

Model: CE28MT2-EH

(E.EUROPE)

Ser Ref No. CE28MT2-EH-01

Product Code: 111325619

Chassis: EC5-A

Original Manual

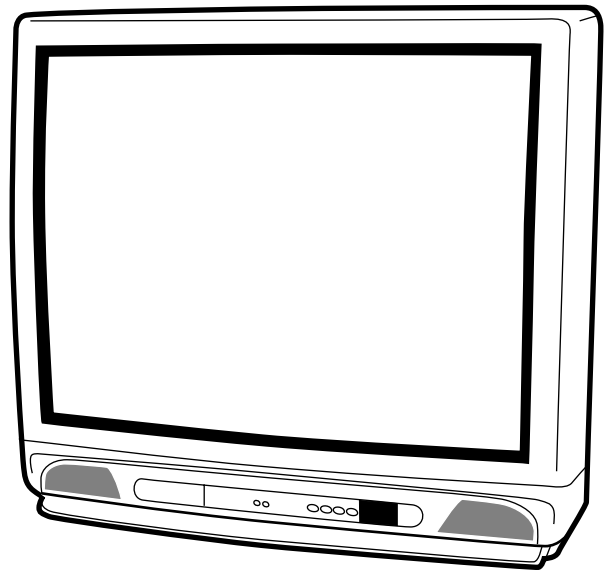

Give complete "SERVICE REF. NO." for parts order or servicing, it is shown on the rating sheet on the cabinet back of the TV set.

Note
This TV receiver will not work properly in foreign countries where the television transmission system and power source differ from the design specifications. Refer to the specifications for the design specifications

SPECIFICATIONS

Power Source	AC220~240V 50Hz
Television System	System B/G,D/K
Colour System	PAL,SECAM
Receiving Channels	VHF : E2~E12,R1~R2 CATV : X,Y,Z,S1~S41 UHF : 21~69
Aerial input impedance	75ohm
Speaker	2 X 16ohm, 5 x 9 cm
Sound output	3W (cont.)
Picture tube	70 cm diagonal, 90°
Visible picture	66 cm (diagonal)
Dimensions (W x H xD)	628 x 567 x 469 mm
Weight	30.4 kg

CONTENTS

	Page
Safety precautions	2
Block diagram	
Main signal routing	3
Power signal routing	4
Circuit description	5~6
Service control adjustments.....	7~8
Circuit alignment	9
Memory IC replacement	10
Special functions.....	11
Cabinet parts list.....	12
Chassis electrical parts list	13~20
Schematic Diagram	loose

SAFETY PRECAUTION

- 1: An isolation transformer should be connected in the power line between the receiver and the AC line when a service is performed on the primary of the converter transformer of the set.
- 2: Comply with all caution and safety-related notes provided on the cabinet back, inside the cabinet, on the chassis or the picture tube.
- 3: When replacing a chassis in the cabinet, always be certain that all the protective devices are installed properly, such as, control knobs, adjustment covers or shields, barriers, isolation resistor-capacitor networks etc. Before returning any television to the customer, the service technician must be sure that it is completely safe to operate without danger of electrical shock.

X-RADIATION PRECAUTION

The primary source of X-RADIATION in the television receiver is the picture tube. The picture tube is specially constructed to limit X-RADIATION emissions. For continued X-RADIATION protection, the replacement tube must be the same type as the original including suffix letter. Excessive high voltage may produce potentially hazardous X-RADIATION. To avoid such hazards, the high voltage must be maintained within specified limit. Refer to this service manual, high voltage adjustment for specific high voltage limit. If high voltage exceeds specified limits, take necessary corrective action. Carefully follow the instructions for +B1 volt power supply adjustment, and high voltage adjustment to maintain the high voltage within the specified limits.

PRODUCT SAFETY NOTICE

Product safety should be considered when a component replacement is made in any area of a receiver. Components indicated by mark $\frac{!}{\Delta}$ in the parts list and the schematic diagram designate components in which safety can be of special significance. It is particularly recommended that only parts designated on the parts list in this manual be used for component replacement designated by mark $\frac{!}{\Delta}$. No deviations from resistance wattage or voltage ratings may be made for replacement items designated by mark $\frac{!}{\Delta}$.

BLOCK DIAGRAM (Main signal routing)

This is a diagram for all models and therefore differs slightly from the actual block diagram.

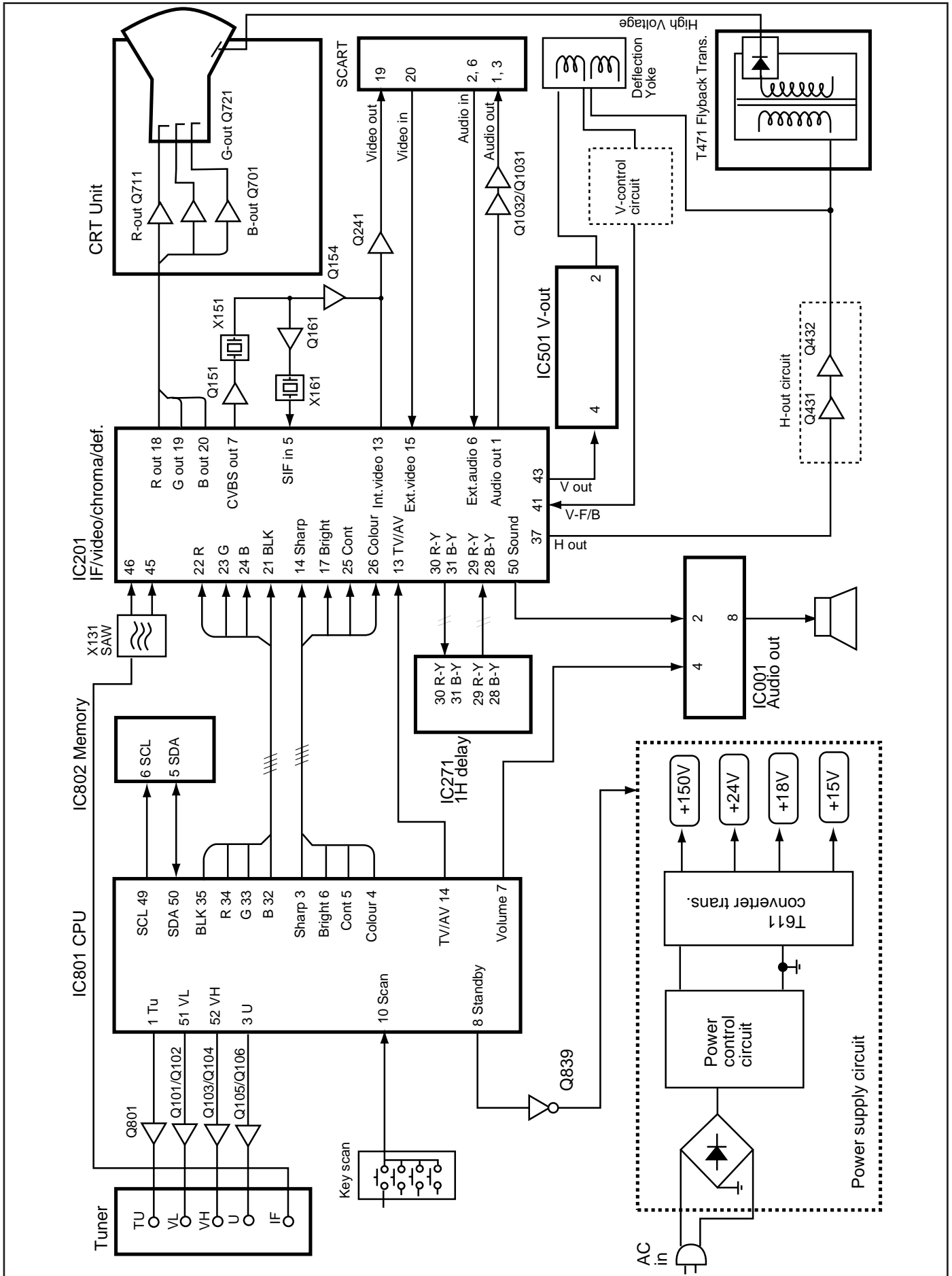

(Power supply routing)

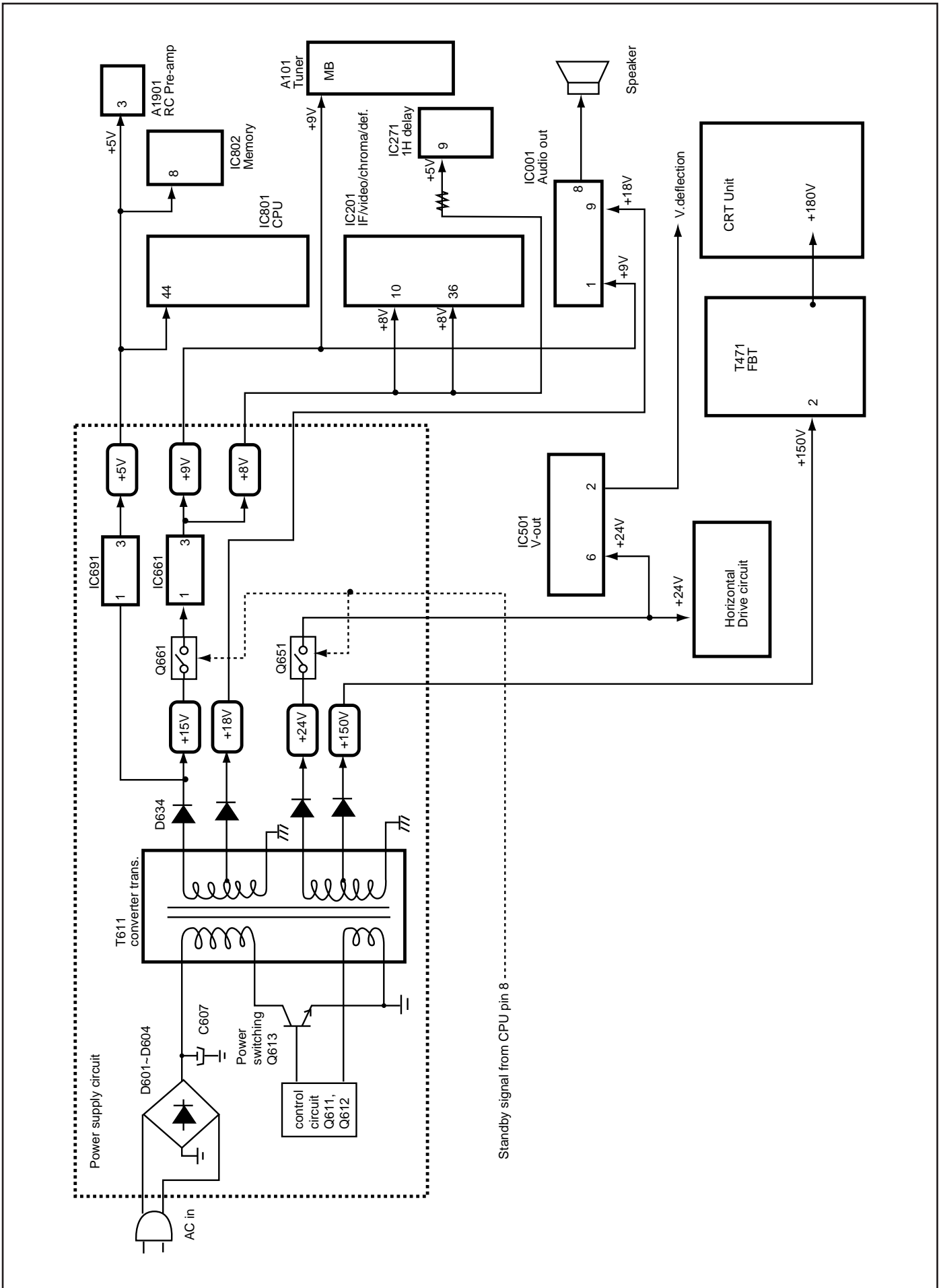

CIRCUIT DESCRIPTION

1. POWER SUPPLY

The power supply circuit of the EC5-A chassis is composed of a rectifier smoothing circuit, an oscillation circuit, a control circuit and an output rectifier circuit. The AC input voltage is full-wave rectified by the rectifier smoothing circuit, and an unstable DC voltage is generated at both terminals of the smoothing capacitor C607. This voltage is input to the oscillation circuit. The oscillation circuit is provided with a blocking oscillator circuit that switches the switching transistor Q613 ON and OFF, and an oscillation frequency and a duty square wave pulse are generated in the input windings according to operation of the control circuit. A square-wave pulse whose size is dependent on the turn ratio of the input and output windings is obtained in the output winding. This is rectified in the output rectifier circuit, and the desired DC voltage is obtained.

2. IF & DEFLECTION (TDA8361)

The IF output signal from the tuner passes through the SAW filter, and it is input to pin45 and pin46 of IC201. The signal input to the IC passes through the IF amplifier, video detection and video amplifier circuits and is output from pin7 as a composite video signal. And after this signal is converted to impedance at Q151, supplies to the video and chroma amplifier stages.

The sync.-separation circuit separates the video signals applied to pin13(internal video signal) or pin15(external video signal) to vertical- and horizontal-sync. signals respectively. The horizontal oscillator requires no external components and is fully integrated. The oscillator is always running when the start-pin36 is supplied with 8V. Horizontal drive signal is output from pin37. VR361 is for adjustment of the horizontal centring. The separated vertical-sync. signal from sync. separation circuit passes through the vertical-separation circuit, and applied to trigger divider circuit. The horizontal oscillation pulse and input vertical sync. pulse are monitored by the trigger divider circuit, and switching 50Hz and 60Hz system, the vertical amplitude automatically adjusted for 50Hz and 60Hz. The output signal from the trigger divider is triggered vertical oscillation circuit consisting of C351, R356 and pin42, and vertical drive pulse is output from pin43. VR501 is for changing the amount of AC feedback applied to pin41 and for adjustment of the vertical amplitude.

3. VIDEO CHROMA & R.G.B. (TDA8361)

The composite video signal output from the pin7 of IC201 passes through Q151-Q154, and it is supplied to pin13. The external video signal output from SCART is supplied to pin15. The video signal input to pin13 or pin15 is separated to luminance (Y) signal and chroma signal in IC201. These pins are used in common with H/V-sync. separation input. The peaking of Y signal is adjusted by DC voltage of pin14. ("SHARPNESS" control) The chroma signal is divided into R-Y and B-Y chroma signals, demodulated in

IC201, and output from pin30 (R-Y) and pin31 (B-Y). These chroma signals pass through the 1H delay line circuit (IC271), and they are input to pin29 (R-Y) and pin28 (B-Y). These R-Y/B-Y signals pass through RGB matrix circuit and RGB selector circuit of IC201. The internal RGB signals are generated in RGB matrix circuit and the RGB selector, consisting linear amplifiers, clamps and selects either the internal RGB signals or the external RGB signals input from pin22(R), pin23(G), pin24(B). Selection is controlled by the voltage at the RGB switch control (pin21) and mixed RGB modes are possible since RGB switching is fast. The RGB switch also functions as a fast blanking pin by blanking the RGB output stages; here internal and external RGB signals are overruled. The colour gain is controlled by DC voltage of pin26. ("COLOUR" control) The contrast control voltage present at pin25, and the brightness control voltage present at pin17 controls DC level of RGB signals. The RGB signals are finally buffered before being available at the RGB output pins [pin20 (R), pin19 (G), pin18 (R)].

4. AUDIO OUTPUT(AN5265)

The audio signal output from pin52 of IC201 is input to pin2 of IC001 and passes through the pre-amplifier circuit and drive circuit, after which it is input to the audio amplifier. The audio amplifier is an SEPP (single-ended, push-pull) OTL type and output to pin8 to directly drive the speaker.

5. VERTICAL OUTPUT (LA7832/LA7833)

An IC (LA7832/LA7833) is used for the vertical output circuit in this chassis. The vertical drive pulse from pin43 of IC201 is input to pin4 of IC501. This pulse drives IC501, and vertical scanning is performed. In the first half of scanning a deflecting current is output from pin2 and passes through the following path:

Vcc(B4) → D501 → pin3 → pin2 → DY → C512 → VR501/R509. An electric charge is then stored in C512. In the last half of scanning the current path is C512 → DY → pin2 → pin1 → VR501/R509 → C512. In this way, an amplifying sawtooth waveform current flows directly to DY to perform electron beam deflection. Next, in the first half of the banking period the vertical drive pulse suddenly becomes OFF, and in order to reduce the current flowing to DY, the current path becomes as follows by the inductance of DY:

DY → pin2 → pin1 → VR501/R509 → C512 → DY. Also, when the charge of DY has dissipated, the current path becomes Vcc24V → pin6 → pin7 → C502 → pin3 → pin2 → DY → C512 → VR501/R509, and when the prescribed current value is reached, the vertical drive pulse becomes ON. This completes one cycle.

6. HORIZONTAL OUTPUT

A horizontal oscillation signal is output from pin37 of IC201 and switches the drive transistor Q431. This switch-

ing signal is current amplified by the drive transformer T431 and drives the output transistor Q432. When Q432 becomes ON, an amplifying current flows directly to DY through C441/C442 → DY → Q432 → GND, and deflection is performed in the last half of the scanning period. Next, when Q432 becomes OFF, the charge that had been stored in DY up to that point releases a resonance current to the resonant capacitors C421/C423 and charges them. The current stored in C421/C423 is then flowed back to DY, and an opposite charge is then stored in DY. This opposite charge then switches the dumper diode in Q432 ON, the resonance state is completed, and an amplifying current is then flowed again directly to DY through the dumper diode. By this means, deflection in the first half of the scanning period is performed, and when Q432 becomes ON at the end of the first half of the scanning period, deflection during the last half is begun, thus completing one cycle.

In the PCC circuit consisting of Q461 and Q462, the parabola signal supplied from the vertical circuit is added at the horizontal output stage and pincushion compensation is performed by varying the DC voltage bias. Further, the ABL voltage is feedback to the base of Q462 to compensate for width variations due to variations in the beam current.

7. CPU <System and Teletext Control>

Pin description

Pin1: Tuning voltage output
Pin2: Band switch output 3 (UHF)
Pin3: Sharpness control output (6-bit DAC)
Pin4: Colour control output (6-bit DAC)
Pin5: Contrast control output(6-bit DAC)
Pin6: Brightness control output(6-bit DAC)
Pin7: Volume control output(6-bit DAC)
Pin8: Power ON/OFF output (Power-On:Lo)
Pin9: AFT signal input
Pin10: Option SW1&Keyboard scan input (DC)
Pin11: Option SW2
Pin12: 50/60Hz switch input (50Hz: Hi)
Pin13: GND
Pin14: TV/AV switch output (TV: Hi)
Pin15: 5.5/6.5 switch output
Pin16: Nega./posi switch output
Pin17: Function signal input for SCART
Pin18: L switch output
Pin19: L' switch output
Pin20: LED drive
Pin21: Ignore output
Pin22: GND
Pin23: CVBS input0 (Internal)
Pin24: CVBS input1 (Internal/External)
Pin25: Black
Pin26: IREF
Pin27: Odd/Even output

Pin28: GND
Pin29: -
Pin30: V-deflection stop output(Stop:Lo)
Pin31: RGB REF
Pin32: Blue output for OSD
Pin33: Green output for OSD
Pin34: Red output for OSD
Pin35: Blanking output for OSD
Pin36: H-sync. input (Horizontal pulse for OSD)
Pin37: V-sync. input (Vertical pulse for OSD)
Pin38~39: Supply (+5V)
Pin 40: OSC GND
Pin 41: Oscillator input for CPU
Pin 42: Oscillator output for CPU
Pin 43: Reset input
Pin 44: Supply (+5V)
Pin 45: Protect signal input (L:Power circuit defects)
Pin 46: Ident. signal input
Pin 47: R/C signal input
Pin 48: Mute output in no picture
Pin 49: I²C bus SCL (Serial clock)
Pin 50: I²C bus SDA (Serial date)
Pin 51: Option SW5 & Band switch output1
Pin 52: Band switch output2

SERVICE CONTROL ADJUSTMENT

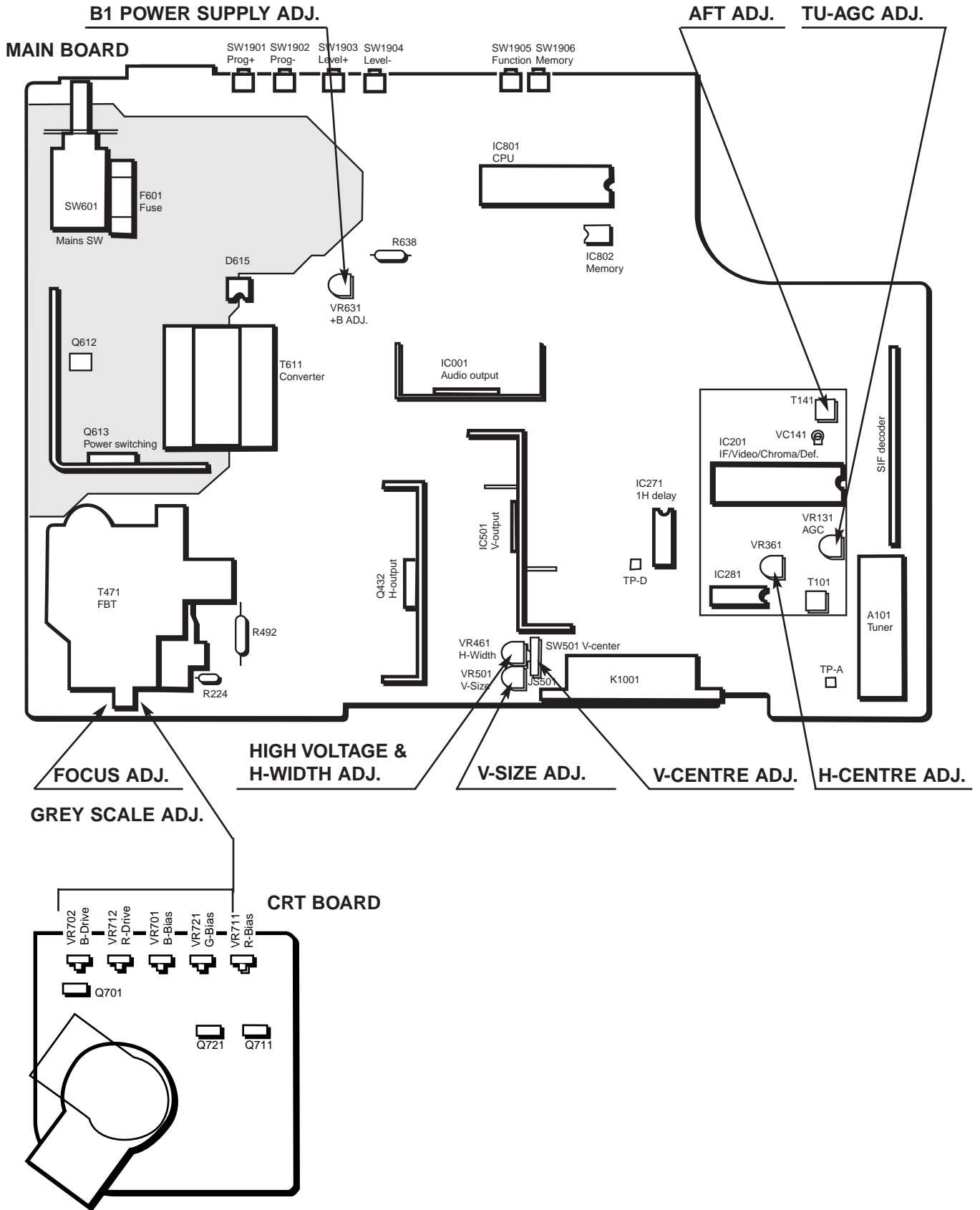

B1 POWER SUPPLY ADJUSTMENT

1. Set VR641 to be mechanical centre before pressing the main switch.
2. Tune the receiver to PAL circular pattern.
3. Set brightness and contrast controls to normal.
4. Connect digital V-meter to the right side terminal of R638.
5. By using VR631, adjust voltage to 150 ± 0.5 V.

AFT ADJUSTMENT

1. Tune the receiver to the clearest station.
2. By using T141, adjust AFT to obtain the best picture.

AGC ADJUSTMENT

NOTE: Do not attempt this adjustment with weak signal.

1. Tune the receiver to the clearest station.
2. Set AGC VR(VR131) in direction which causes snow noise to appear, then in the opposite direction until snow noise just disappears.

GREY SCALE ADJUSTMENT

[SCREEN VR ADJUSTMENT]

1. Tune the receiver to the white pattern.
2. Set brightness and contrast controls to normal.
3. Set VR702 and VR712 to be mechanical centre.
4. Turn VR701, VR711 and VR721 fully counter-clockwise.
5. Connect a short lead between pin30 of IC801 and GND to enter the service mode.
6. Set screen VR for one colour to be just visible.

[BIAS VR ADJUSTMENT]

7. By using VR701, VR711 or VR721, adjust line to be white.
8. Disconnect a short lead.

[DRIVE VR ADJUSTMENT]

9. By using VR701 and VR711, adjust white balance.

HIGH VOLTAGE & WIDTH ADJUSTMENT

[HIGH VOLTAGE ADJUSTMENT]

1. Tune the receiver to circular pattern.
2. Set brightness and contrast controls to maximum.
3. Connect digital V-meter to both terminals of R224, and high voltage meter to CRT anode.
4. Confirm high voltage to be 26.0 ± 1 KV at beam current 1.4mA, and less than 29.0 KV at 0 beam current.

[H-WIDTH ADJUSTMENT]

5. Adjust VR461 to obtain proper H- width.
6. Reconfirm high voltage.

H-CENTRE ADJUSTMENT

1. Tune the receiver to circular pattern.
2. Adjust H-centre by using VR361.

V-CENTRE ADJUSTMENT

1. Tune the receiver to circular pattern.
2. Adjust V-centre by using SW501.

V-SIZE ADJUSTMENT

1. Tune the receiver to circular pattern.
2. Adjust V-size by using VR501.

FOCUS ADJUSTMENT

By using FOCUS VR, adjust focus control for the best scanning lines.

CIRCUIT ALIGNMENT

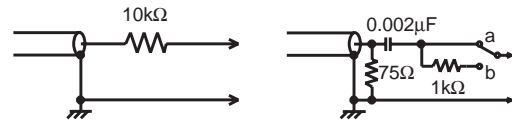

Input probe

Output probe

VIF alignment

SETTING		Adjustment	Waveform
DC 15.5V AGC voltage (4.3-4.5V) Output probe	C644 + IC201-pin48 IC201-pin45 (Side b)	By using T141, adjust "P" to be maximum amplitude.	
Input probe	IC201-pin7		
Marker frequency Sweep ATT 0dB=176mVrms/75	38.9MHz 20dB		

MEMORY IC REPLACEMENT (Important Notice)

When you replace a memory IC (IC802), it is necessary to initialise the IC as follows.

A. Initialisation of Memory IC

1. When you press and hold the **Recall** button on the RC transmitter and then press the **Prog +** button on the TV set, the following picture will appear on the screen.



2. Confirm SET number of all items is "0" by pressing the **Function** button.
3. If it is not "0", change to "0" by the **Level (+/-)** button. (Changing the SET number, automatically memorised.)
4. Press the **Recall** button, to return the normal TV mode.

For more information, please refer to "special functions" on the instruction manual.

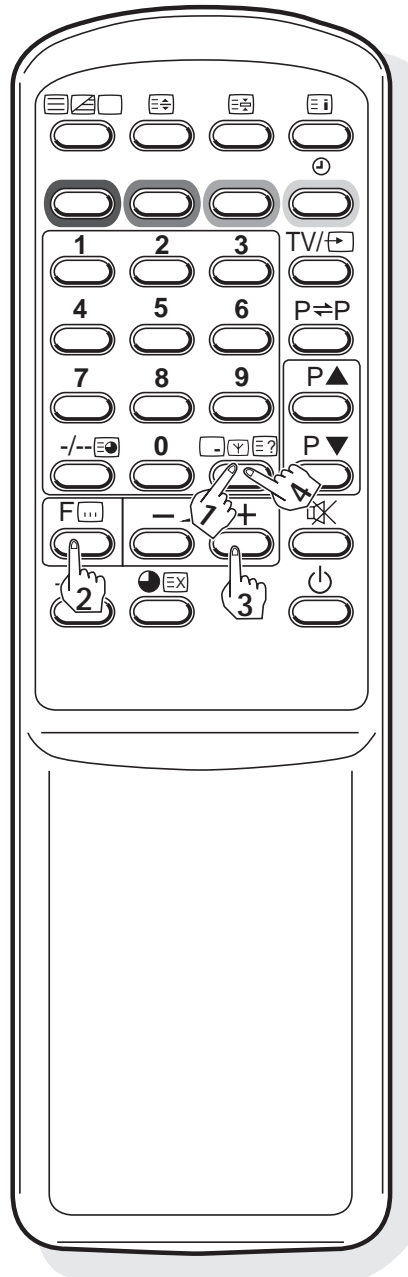
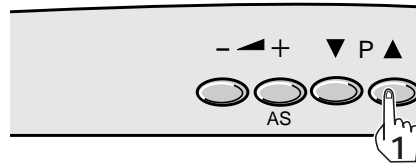

Special Function

- Maximum volume setting and prohibition of presetting
- Start up programme position

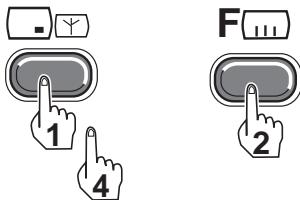
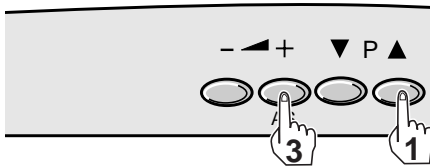
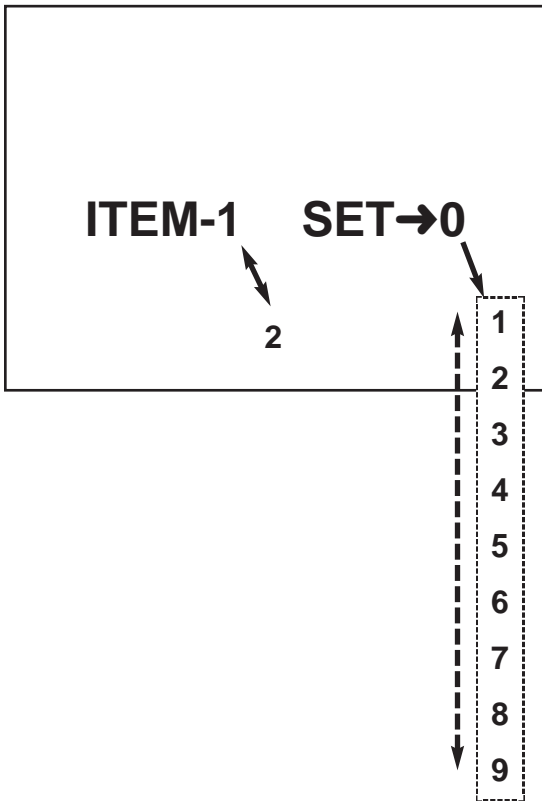

This TV set allows you to set up the following special functions.

■ Maximum volume setting and prohibition of presetting

ITEM-1

Sets the current volume as the maximum volume level and prohibition of presetting.

SET→ 0 NO
SET→ 1 YES

■ Start up programme position

ITEM-2

Presets the programme position when the set is switched on.

SET→ 0 Last programme position start
SET→ 1 Programme position "1" start
SET→ 2 Programme position "2" start
SET→ 3 Programme position "3" start
SET→ 4 Programme position "4" start
SET→ 5 Programme position "5" start
SET→ 6 Programme position "6" start
SET→ 7 Programme position "7" start
SET→ 8 Programme position "8" start
SET→ 9 "AV" start

SETTING PROCEDURE

- 1 Press and hold the button on the **Remote control handset** and then press the **P▲** button on the **TV set**.
- 2 To select the "ITEM" number, press the **F** button on the **remote control handset**.
- 3 To select the "SET" number, press the button repeatedly.
- 4 To return to the normal TV mode, press the button.

- ✍ The setting conditions of all items can be confirmed.
- ✍ Special functions are not cancelled if the TV set is switched off or the mains disconnected.

SERVICE REF. NO. CE28MT2-EH-01
CABINET PARTS LIST

Note: Parts order must contain Service Ref. No., Part No., and descriptions.

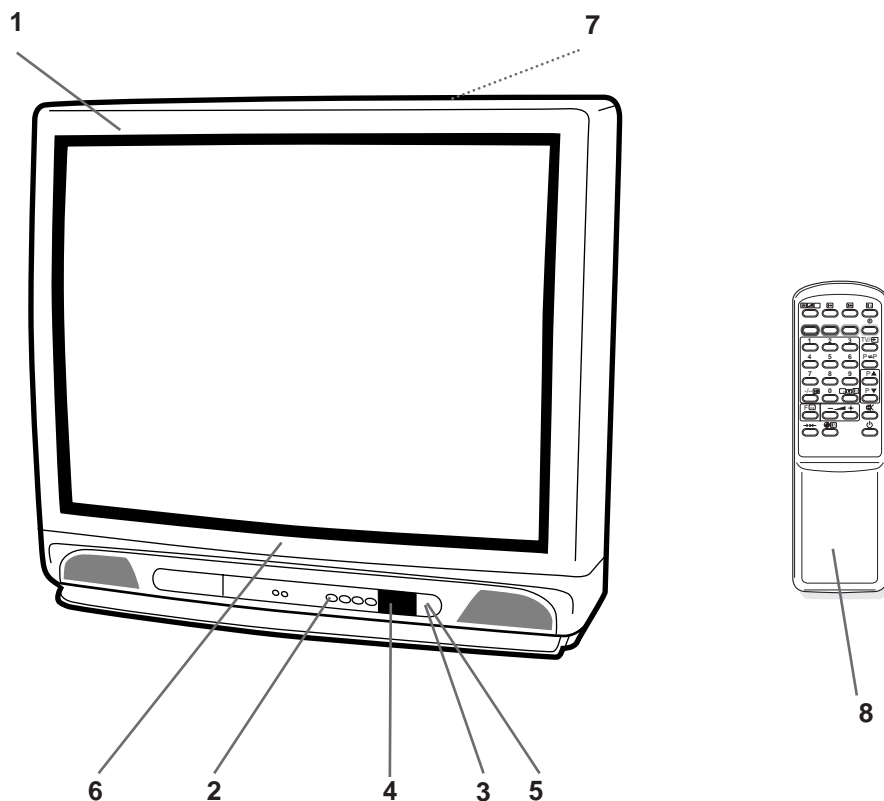

Ref. No.	Part No.	Description	Ref. No.	Part No.	Description
CABINET PARTS					
1	610 267 0868	ASSY, CABINET FR- F4ZS			
2	610 266 1811	BUTTON UNITED- F2ZE			
3	610 267 1155	BUTTON POWER- F4ZC			
4	610 263 9292	DEC BOARD- E8YBV			
	610 252 7476	DEC SHEET REAR- E6YB			
	610 252 9609	DEC SHEET BOTTOM- E6YB			
	610 260 0148	HOLDER RC GBR- BLFA			
	610 265 4202	HOLDER DC- F3SCM			
	610 254 8433	SPACER CUSHION SIUK- E7LC			
5	610 261 3032	SPRING- E7GC			
6	645 003 9256	BADGE, SANYO*46. 2X13. 5L45			
	610 098 2659	FOOT- BZYA			
	610 225 6383	WIRE BAND- L280			
	610 226 3985	WIRE BAND- L110			
7	610 262 2089	CABINET BACK- B- E6ZV			
ACCESSORIES					
8	JXYC	RC TRANSMITTER			
	610 267 2695	INST MANUAL- F4AZ//ZZ			
	645 000 6708	BATTERY, MANGAN, COMPOSITE			

CHASSIS ELECTRICAL PARTS LIST



Product safety should be considered when a component replacement is made in any area of a receiver. Components indicated by a mark in this parts list and the circuit diagram show components whose value have special significance to product safety. It is particularly recommended that only parts specified on the following parts list be used for components replacement pointed out by the mark.

Note: Parts order must contain Service Ref. No., Part No., and descriptions.

Ref. No.	Part No.	Description	Ref. No.	Part No.	Description
----------	----------	-------------	----------	----------	-------------

Read description in the Capacitor and Resistor as follows:

CAPACITOR

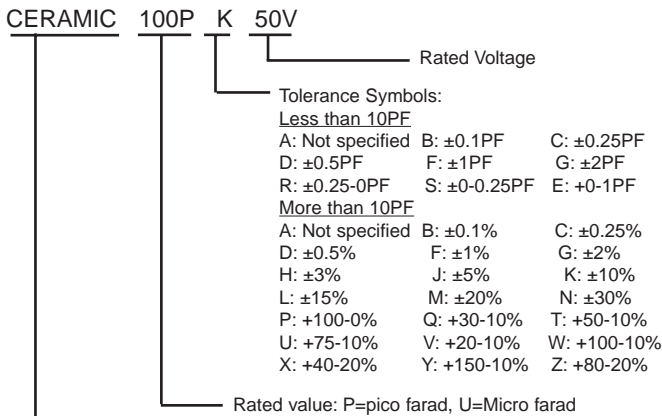

Material:

- CERAMIC..... Ceramic
- MT-PAPER..... Metallized Paper
- POLYESTER..... Polyester
- MT-POLYEST..... Metallized Polyester
- POLYPRO..... Polypropylene
- MT-POLYPRO..... Metallized Polypropylene
- COMPO FILM..... Composite film
- MT-COMPO..... Metallized Composite
- STYRENE..... Styrene
- TA-SOLID..... Tantalum Solid
- AL-SOLID..... Aluminium Solid
- ELECT..... Electrolytic
- NP-ELECT..... Non-polarised Electrolytic
- OS-SOLID..... Aluminium Solid with Organic Semiconductive Electrolytic
- DL-ELECT..... Double Layered Electrolytic

RESISTOR

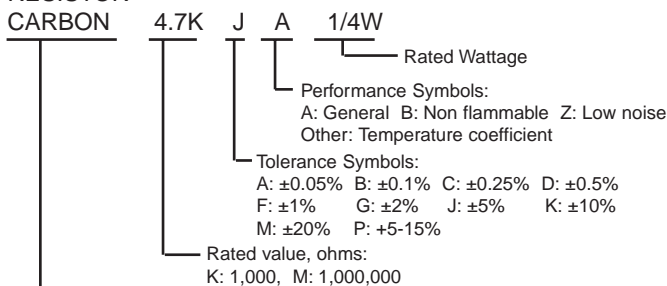

Material:

- CARBON..... Carbon
- MT-FILM..... Metal Film
- OXIDE-MT..... Oxide Metal Film
- SOLID..... Composition
- MT-GLAZE..... Metal Glaze
- WIRE WOUND... Wire Wound
- CERAMIC RES.. Ceramic
- FUSIBLE RES.... Fusible

OUT OF CIRCUIT BOARD

PICTURE TUBE

Q901 414 007 1203 CRT A66ECY13X38

COIL

L901 645 003 0048 COIL, DEGAUSSING
 645 003 0055 COIL, DEGAUSSING

MISCELLANEOUS

SP901 610 233 8409 SPEAKER
 645 005 6819 SPEAKER, 16
 SP902 610 233 8409 SPEAKER
 645 005 6819 SPEAKER, 16
 W901 645 012 7632 ASSY, CORD, POWER
 W902 610 204 6090 GROUNDING CONNECTOR

1AA0B10H023DA ASSY,PWB,MAIN F4ZZV

TRANSISTOR

Q101	406	007	1901	TR	JC556A
Q102	406	007	2106	TR	JC546A
Q1021	406	007	1901	TR	JC556A
Q1022	406	007	2106	TR	JC546A
Q103	406	007	1901	TR	JC556A
Q1031	406	007	1901	TR	JC556A
Q1032	406	007	2106	TR	JC546A
Q104	406	007	2106	TR	JC546A
Q105	406	007	1901	TR	JC556A
Q106	406	007	2106	TR	JC546A
Q121	406	007	2106	TR	JC546A
Q151	406	007	2106	TR	JC546A
Q152	406	007	2106	TR	JC546A
Q153	406	007	1901	TR	JC556A
Q154	406	007	1901	TR	JC556A
Q161	406	007	2106	TR	JC546A
Q162	406	007	2106	TR	JC546A
Q163	406	007	2106	TR	JC546A
Q2001	406	007	2106	TR	JC546A
Q201	406	007	2106	TR	JC546A
Q203	406	007	2106	TR	JC546A
Q241	406	007	2106	TR	JC546A
Q251	406	007	1901	TR	JC556A
Q431	405	018	0616	TR	2SC3332-S
Q432	405	095	0209	TR	2SD1556-3E
Q432H	610	252	1108	H	HEAT SINK E7LC
Q461	405	064	7307	TR	2SB1274-Q-RA
Q461H	610	251	5916	HEAT SINK	PCC E7LC
Q462	406	007	2106	TR	JC546A
Q611	406	007	1901	TR	JC556A
Q612	405	058	0208	TR	2SC3807-R-CTV-YA
Q613	405	018	9203	TR	2SC3895-T-CTV-YB
Q613H	610	256	1210	ASSY	HEATSINK POWER-E8JE
Q631	406	007	2106	TR	JC546A
Q651	405	009	7003	TR	2SB985-T
Q661	405	008	4805	TR	2SB764-E

Ref. No.	Part No.	Description	Ref. No.	Part No.	Description
Q682	406 007 2106	TR JC546A	C172	403 068 0419	CERAMIC 0.1U Z 25V
Q685	406 007 2106	TR JC546A	C173	403 041 8804	ELECT 10U M 16V
Q686	406 007 1901	TR JC556A	C2001	403 068 0419	CERAMIC 0.1U Z 25V
Q801	405 118 4217	TR PH2369	C2002	403 068 0419	CERAMIC 0.1U Z 25V
Q831	406 007 2106	TR JC546A	C2003	403 068 0419	CERAMIC 0.1U Z 25V
Q839	406 007 2106	TR JC546A	C201	403 014 3409	CERAMIC 18P J 50V
Q861	406 007 1901	TR JC556A	C202	403 237 8057	MT-COMPO 0.1U J 50V
Q871	406 007 2106	TR JC546A	C203	403 073 9117	CERAMIC 4700P K 50V
Q872	406 007 2106	TR JC546A	C204	403 068 0419	CERAMIC 0.1U Z 25V
Q873	406 007 2106	TR JC546A	C205	403 068 0419	CERAMIC 0.1U Z 25V
Q874	406 007 2106	TR JC546A	C206	403 068 0419	CERAMIC 0.1U Z 25V
Q875	406 007 2106	TR JC546A	C207	403 068 0419	CERAMIC 0.1U Z 25V
			C208	403 068 0419	CERAMIC 0.1U Z 25V
			C212	403 049 9803	ELECT 2.2U M 50V
			C215	403 067 7895	MT-COMPO 0.47 J 50V
			C222	404 045 6605	NP-ELECT 2.2U M 50V
			C231	403 068 0419	CERAMIC 0.1U Z 25V
			C233	403 068 0419	CERAMIC 0.1U Z 25V
			C251	403 043 6006	ELECT 330U M 16V
			C271	403 069 1712	CERAMIC 1000P K 50V
			C272	403 069 1712	CERAMIC 1000P K 50V
			C273	403 069 9510	CERAMIC CHIP 0.01Z 50V
			C275	403 069 9510	CERAMIC CHIP 0.01Z 50V
			C276	403 069 9510	CERAMIC CHIP 0.01Z 50V
			C277	403 069 9510	CERAMIC CHIP 0.01Z 50V
			C282	403 044 1703	ELECT 470U M 16V
			C283	403 069 9510	CERAMIC CHIP 0.01Z 50V
			C284	403 270 3413	MT-POLYEST 0.22U K 63V
			C285	403 068 0419	CERAMIC 0.1U Z 25V
			C351	403 237 8057	MT-COMPO 0.1U J 50V
			C352	403 179 1213	POLYESTER 4700P J 50V
			C353	403 073 9117	CERAMIC 4700P K 50V
			C354	403 049 0008	ELECT 1U M 50V
			C361	403 072 5615	CERAMIC 2700P K 50V
			C362	403 069 9510	CERAMIC CHIP 0.01Z 50V
			C363	403 042 2405	ELECT 100U M 16V
			△ C421	404 046 8806	MT-POLYPRO 6200P J 1.5K
			△ C422	404 040 7805	MT-POLYPRO 5600P J 1.5K
			C424	403 299 3210	POLYPRO 0.027U J 400V
			C425	403 083 3409	POLYPRO 0.015U J 400V
			C429	403 066 6106	MT-POLYEST 0.47U J 250V
			C431	403 068 5612	CERAMIC 0.056U Z 25V
			C432	403 075 7101	CERAMIC 1000P K 500V
			C433	403 076 3102	CERAMIC 3900P K 500V
			C434	403 054 0703	ELECT 47U M 35V
			C438	403 179 3811	POLYESTER 0.01U K 50V
			△ C441	403 309 2100	POLYPRO 0.3U J 400V
			C445	403 049 4204	ELECT 10U M 50V
			C462	403 049 0008	ELECT 1U M 50V
			C464	403 067 7895	MT-COMPO 0.47 J 50V
			C465	403 066 0104	MT-POLYEST 2.2U K 100V
			C466	403 237 8057	MT-COMPO 0.1U J 50V
			C467	403 040 3701	ELECT 220U M 10V
			C468	403 045 5809	ELECT 22U M 25V
			C470	403 069 8305	CERAMIC 0.01U Z 50V
			C491	403 076 5304	CERAMIC 680P K 500V
			C492	403 050 2800	ELECT 22U M 50V
			C501	403 054 1502	ELECT 470U M 35V
			C502	403 217 1103	ELECT 220U M 35V
			C503	403 024 2112	CERAMIC 39P J 50V
			C504	403 069 9510	CERAMIC CHIP 0.01Z 50V
			C505	403 075 7101	CERAMIC 1000P K 500V
			C506	403 188 0907	MT-POLYEST 0.22U K 100V
			C511	403 183 7901	MT-POLYEST 0.1U K 100V
			C512	403 110 1735	ELECT 2200U M 25V
			C513	403 049 4204	ELECT 10U M 50V
			C520	403 009 5718	CERAMIC 100P J 50V
			△ C601	404 060 7205	MT-POLYEST 0.1U M 250V
			△ C602	404 060 7205	MT-POLYEST 0.1U M 250V
			C606	403 076 7130	CERAMIC 1000P M 1K
			C607	404 044 5005	ELECT 220U M 400V
			C614	403 237 8057	MT-COMPO 0.1U J 50V
INTEGRATED CIRCUIT					
IC001	409 073 1509	IC AN5265			
IC001H	610 256 1227	AUDIO HEAT SINK-E8CC			
IC201	409 380 8802	IC TDA8362/N5			
IC271	409 371 7005	IC TDA4665/V4			
IC281	409 374 5503	IC TDA8395/N2			
IC501	409 192 5709	IC LA7833			
IC501H	610 251 5909	V HEAT SINK E7LC			
IC661	409 367 2809	IC BA178M09T			
IC661H	610 266 2542	HEAT SINK F2TC F9-4-186E			
IC661P1	645 008 4058	TERMINAL PLUG			
IC691	409 241 5407	IC BA178M05T			
IC801	410 276 7106	SAA5290ZP/065 EC5/VER1			
IC802	409 333 3700	IC 24LC02B/P			
CAPACITOR					
C001	403 043 3906	ELECT 33U M 16V			
C002	403 067 7895	MT-COMPO 0.47 J 50V			
C003	403 179 2715	POLYESTER 2200P J 50V			
C004	403 051 0607	ELECT 4.7U M 50V			
C005	403 041 8804	ELECT 10U M 16V			
C006	403 041 8804	ELECT 10U M 16V			
C010	403 237 8057	MT-COMPO 0.1U J 50V			
C011	403 045 1504	ELECT 1000U M 25V			
C012	403 199 9708	ELECT 470U M 25V			
C013	403 086 2300	NP-ELECT 1U M 50V			
C020	403 069 8305	CERAMIC 0.01U Z 50V			
C100	403 043 9106	ELECT 47U M 16			
C1001	403 009 5718	CERAMIC 100P J 50V			
C1002	403 067 7895	MT-COMPO 0.47 J 50V			
C1003	403 069 9510	CERAMIC CHIP 0.01Z 50V			
C1004	403 041 8804	ELECT 10U M 16V			
C101	403 043 9106	ELECT 47U M 16V			
C102	403 069 1712	CERAMIC 1000P K 50V			
C1021	403 068 0419	CERAMIC 0.1U Z 25V			
C105	403 049 0008	ELECT 1U M 50V			
C106	403 069 9510	CERAMIC CHIP 0.01Z 50V			
C121	403 068 0419	CERAMIC 0.1U Z 25V			
C131	401 037 5014	MT-GLAZE 0.000 ZA 1/10W			
C132	403 069 1712	CERAMIC 1000P K 50V			
C133	403 069 9510	CERAMIC CHIP 0.01Z 50V			
C134	403 049 9803	ELECT 2.2U M 50V			
C135	403 068 0419	CERAMIC 0.1U Z 25V			
C136	403 194 4609	ELECT 470U M 16V			
C137	403 068 0419	CERAMIC 0.1U Z 25V			
C138	403 069 9510	CERAMIC CHIP 0.01Z 50V			
C140	403 010 8517	CERAMIC CERAMIC 1			
C141	403 028 4419	CERAMIC 56P J 50V			
C142	403 068 0419	CERAMIC 0.1U Z 25V			
C143	403 073 4211	CERAMIC 3900P K 50V			
C151	403 020 0419	CERAMIC 27P J 50V			
C152	403 026 2813	CERAMIC 47P J 50V			
C153	403 033 4510	CERAMIC 82P J 50V			
C154	403 009 5718	CERAMIC 100P J 50V			
C155	403 069 9510	CERAMIC CHIP 0.01Z 50V			
C156	403 069 9510	CERAMIC CHIP 0.01Z 50V			
C160	403 069 1712	CERAMIC 1000P K 50V			
C161	403 072 5011	CERAMIC 270P K 50V			
C171	403 049 0008	ELECT 1U M 50V			

Ref. No.	Part No.	Description	Ref. No.	Part No.	Description
C615	403 179 3217	POLYESTER 0.015U J 50V	R1033	401 037 6714	MT- GLAZE 1.2K JA 1/10W
C616	403 165 8427	CERAMIC 680P K 2K	R104	401 037 6813	MT- GLAZE 12K JA 1/10W
C617	403 179 2418	POLYESTER 0.022U K 50V	R105	401 038 6515	MT- GLAZE 47K JA 1/10W
△ C621	404 073 3904	CER 1000P M KX 250V	R106	401 037 6813	MT- GLAZE 12K JA 1/10W
△ C624	404 073 5106	CER 470P M KX 250V	R109	401 037 5014	MT- GLAZE 0.000 ZA 1/10W
C631	403 165 6126	CERAMIC 470P K 1K	R110	401 037 5014	MT- GLAZE 0.000 ZA 1/10W
C634	403 165 6126	CERAMIC 470P K 1K	R121	401 038 6515	MT- GLAZE 47K JA 1/10W
C641	404 055 9801	ELECT 220U M 200V	R122	401 038 0919	MT- GLAZE 220K JA 1/10W
C643	403 214 4404	ELECT 470U M 35V	R123	401 038 0919	MT- GLAZE 220K JA 1/10W
C644	403 148 0404	ELECT 1000U M 25V	R133	401 037 9111	MT- GLAZE 180 JA 1/10W
C645	403 148 0404	ELECT 1000U M 25V	R134	401 039 0413	MT- GLAZE 8.2K JA 1/10W
C662	403 194 4609	ELECT 470U M 16V	R135	401 038 0810	MT- GLAZE 22K JA 1/10W
C663	403 040 3701	ELECT 220U M 10V	R137	401 037 5212	MT- GLAZE 100 JA 1/10W
C685	403 049 0008	ELECT 1U M 50V	R138	401 038 7710	MT- GLAZE 5.6K JA 1/10W
C691	403 039 6508	ELECT 100U M 10V	R141	401 038 9219	MT- GLAZE 6.8K JA 1/10W
C800	401 037 5014	MT- GLAZE 0.000 ZA 1/10W	R150	401 037 5410	MT- GLAZE 1K JA 1/10W
C801	403 069 9510	CERAMIC CHIP 0.01Z 50V	R151	401 019 1040	CARBON 390 JA 1/4W
C805	403 051 0607	ELECT 4.7U M 50V	R152	401 037 9111	MT- GLAZE 180 JA 1/10W
C807	403 070 2616	CERAMIC 0.1U K 50V	R155	401 037 5410	MT- GLAZE 1K JA 1/10W
C814	403 046 9905	ELECT 4.7U M 25V	R156	401 038 6416	MT- GLAZE 4.7K JA 1/10W
C819	403 046 9905	ELECT 4.7U M 25V	R157	401 037 5410	MT- GLAZE 1K JA 1/10W
C824	403 049 0008	ELECT 1U M 50V	R158	401 037 5410	MT- GLAZE 1K JA 1/10W
C829	403 049 0008	ELECT 1U M 50V	R159	401 037 5410	MT- GLAZE 1K JA 1/10W
C833	403 069 5611	CERAMIC 0.01U K 50V	R160	401 037 5410	MT- GLAZE 1K JA 1/10W
C834	403 049 0008	ELECT 1U M 50V	R161	401 019 1040	CARBON 390 JA 1/4W
C841	403 069 9510	CERAMIC CHIP 0.01Z 50V	R162	401 037 5014	MT- GLAZE 0.000 ZA 1/10W
C851	403 069 9510	CERAMIC CHIP 0.01Z 50V	R163	401 025 7429	CARBON 220 JA 1/6W
C861	403 179 0810	POLYESTER 0.0056U J 5	R164	401 038 6218	MT- GLAZE 47 JA 1/10W
C870	403 022 8215	CERAMIC 33P J 50V	R165	401 037 6813	MT- GLAZE 12K JA 1/10W
C871	403 068 0419	CERAMIC 0.1U Z 25V	R166	401 027 5225	CARBON 680 JA 1/6W
C872	403 043 9106	ELECT 47U M 16V	R167	401 038 6218	MT- GLAZE 47 JA 1/10W
C873	403 018 0513	CERAMIC 22P J 50V	R168	401 037 6813	MT- GLAZE 12K JA 1/10W
C874	403 018 0513	CERAMIC 22P J 50V	R169	401 027 5225	CARBON 680 JA 1/6W
C875	403 068 0419	CERAMIC 0.1U Z 25V	R170	401 038 7710	MT- GLAZE 5.6K JA 1/10W
C878	403 073 9117	CERAMIC 4700P K 50V	R171	401 037 5618	MT- GLAZE 10K JA 1/10W
C879	403 068 0419	CERAMIC 0.1U Z 25V	R173	401 037 5014	MT- GLAZE 0.000 ZA 1/10W
C881	403 069 9510	CERAMIC CHIP 0.01Z 50V	R174	401 037 8015	MT- GLAZE 15K JA 1/10W
C882	403 049 4204	ELECT 10U M 50V	R1901	401 027 3023	CARBON 56K JA 1/6W
C885	403 069 1712	CERAMIC 1000P K 50V	R1902	401 025 1922	CARBON 15K JA 1/6W
RESISTOR			R1903	401 023 2842	CARBON 8K2 JA 1/4W
R001	401 018 1645	CARBON 33 JA 1/4W	R1904	401 026 9927	CARBON 4K7 JA 1/6W
R002	401 027 2323	CARBON 560 JA 1/6W	R1905	401 038 2111	MT- GLAZE 2.7K JA 1/10W
R003	401 024 7430	CARBON 10K JA 1/6W	R1906	401 038 0711	MT- GLAZE 2.2K JA 1/10W
R004	401 024 7024	CARBON 1K JA 1/6W	R1907	401 037 7919	MT- GLAZE 1.5K JA 1/10W
R006	401 024 7430	CARBON 10K JA 1/6W	R1908	401 038 3514	MT- GLAZE 330 JA 1/10W
R010	401 024 7024	CARBON 1K JA 1/6W	R1909	401 037 5618	MT- GLAZE 10K JA 1/10W
R1001	401 037 6813	MT- GLAZE 12K JA 1/10W	R1911	401 026 9620	CARBON 470 JA 1/6W
R1002	401 037 6813	MT- GLAZE 12K JA 1/10W	R1912	401 025 7825	CARBON 2K2 JA 1/6W
R1003	401 038 7710	MT- GLAZE 5.6K JA 1/10W	R2001	401 038 2210	MT- GLAZE 27K JA 1/10W
R1004	401 038 7611	MT- GLAZE 560 JA 1/10W	R2002	401 037 5618	MT- GLAZE 10K JA 1/10W
R1005	401 037 5717	MT- GLAZE 100K JA 1/10W	R2003	401 037 6813	MT- GLAZE 12K JA 1/10W
R1007	401 027 6628	CARBON 75 JA 1/6W	R2004	401 037 7810	MT- GLAZE 150 JA 1/10W
R1008	401 026 7428	CARBON 39K JA 1/6W	R2005	401 013 6447	CARBON 12K JA 1/4W
R1009	401 038 2210	MT- GLAZE 27K JA 1/10W	R201	401 039 0413	MT- GLAZE 8.2K JA 1/10W
R101	401 038 6515	MT- GLAZE 47K JA 1/10W	R202	401 037 5717	MT- GLAZE 100K JA 1/10W
R1011	401 027 6628	CARBON 75 JA 1/6W	R203	401 037 5212	MT- GLAZE 100 JA 1/10W
R1015	401 027 6628	CARBON 75 JA 1/6W	R204	401 037 5212	MT- GLAZE 100 JA 1/10W
R1016	401 027 6628	CARBON 75 JA 1/6W	R205	401 037 5212	MT- GLAZE 100 JA 1/10W
R1019	401 027 6628	CARBON 75 JA 1/6W	R211	401 016 4836	CARBON 22K JA 1/4W
R102	401 037 6813	MT- GLAZE 12K JA 1/10W	R212	401 022 3147	CARBON 6K8 JA 1/4W
R1020	401 027 6628	CARBON 75 JA 1/6W	R213	401 037 8015	MT- GLAZE 15K JA 1/10W
R1021	401 038 6317	MT- GLAZE 470 JA 1/10W	R217	401 038 0810	MT- GLAZE 22K JA 1/10W
R1022	401 024 7430	CARBON 10K JA 1/6W	R218	401 015 2744	CARBON 1K8 JA 1/4W
R1023	401 020 2053	CARBON 4.7K JA 1/4W	R222	401 013 7335	CARBON 120K JA 1/4W
R1026	401 038 7611	MT- GLAZE 560 JA 1/10W	R223	401 026 4625	CARBON 33K JA 1/6W
R1027	401 038 7611	MT- GLAZE 560 JA 1/10W	R224	401 012 5748	CARBON 1K JA 1/4W
R1028	401 038 7611	MT- GLAZE 560 JA 1/10W	R226	401 037 5717	MT- GLAZE 100K JA 1/10W
R1029	401 038 5013	MT- GLAZE 390 JA 1/10W	R227	401 024 7430	CARBON 10K JA 1/6W
R103	401 038 6515	MT- GLAZE 47K JA 1/10W	R231	401 037 5014	MT- GLAZE 0.000 ZA 1/10W
R1031	401 037 6714	MT- GLAZE 1.2K JA 1/10W	R232	401 037 5212	MT- GLAZE 100 JA 1/10W
R1032	401 038 3613	MT- GLAZE 3.3K JA 1/10W	R241	401 038 6317	MT- GLAZE 470 JA 1/10W
			R242	401 025 7429	CARBON 220 JA 1/6W

Ref. No.	Part No.	Description	Ref. No.	Part No.	Description
R243	401 025 7429	CARBON 220 JA 1/6W	R662	401 069 5607	OXIDE-MT 8.2 JA 2W
R251	401 037 5014	MT- GLAZE 0.000 ZA 1/10W	R663	401 013 5341	CARBON 1K2 JA 1/4W
R252	401 037 5618	MT- GLAZE 10K JA 1/10W	R666	401 008 0215	CARBON 18 JA 1/2W
R253	401 024 7430	CARBON 10K JA 1/6W	R681	401 012 7049	CARBON 10K JA 1/4W
R271	401 016 2644	CARBON 220 JA 1/4W	R686	401 016 5843	CARBON 220K JA 1/4W
R282	401 037 8114	MT- GLAZE 150K JA 1/10W	R687	401 021 5033	CARBON 560K JA 1/4W
R351	401 024 6720	CARBON 100 JA 1/6W	R688	401 012 7049	CARBON 10K JA 1/4W
R352	401 037 5816	MT- GLAZE 1M JA 1/10W	R689	401 025 8228	CARBON 22K JA 1/6W
R356	401 037 5212	MT- GLAZE 100 JA 1/10W	R800	401 038 0711	MT- GLAZE 2.2K JA 1/10W
R357	401 037 5618	MT- GLAZE 10K JA 1/10W	R801	401 037 5014	MT- GLAZE 0.000 ZA 1/10W
R361	401 038 5419	MT- GLAZE 390K JA 1/10W	R802	401 038 0711	MT- GLAZE 2.2K JA 1/10W
R363	401 038 0810	MT- GLAZE 22K JA 1/10W	R803	401 037 9418	MT- GLAZE 180K JA 1/10W
R364	401 037 5212	MT- GLAZE 100 JA 1/10W	R804	401 012 7049	CARBON 10K JA 1/4W
R365	401 038 6416	MT- GLAZE 4.7K JA 1/10W	R805	401 039 0413	MT- GLAZE 8.2K JA 1/10W
R371	401 012 7049	CARBON 10K JA 1/4W	R806	401 066 2104	OXIDE-MT 18K JA 2W
R429	402 068 0204	WIRE WOUND 10 JA 5W	R807	401 037 5618	MT- GLAZE 10K JA 1/10W
R432	401 037 5410	MT- GLAZE 1K JA 1/10W	R811	401 038 6416	MT- GLAZE 4.7K JA 1/10W
R433	401 007 1134	CARBON 1K JA 1/2W	R812	401 038 0711	MT- GLAZE 2.2K JA 1/10W
R434	401 009 9346	CARBON 390 JA 1/2W	R813	401 038 5112	MT- GLAZE 3.9K JA 1/10W
R444	401 058 3706	OXIDE-MT 1K JA 1W	R814	401 038 3613	MT- GLAZE 3.3K JA 1/10W
R447	401 026 9927	CARBON 4K7 JA 1/6W	R816	401 038 0711	MT- GLAZE 2.2K JA 1/10W
R448	401 009 5843	CARBON 330 JA 1/2W	R817	401 037 5618	MT- GLAZE 10K JA 1/10W
R463	401 025 1625	CARBON 1K5 JA 1/6W	R818	401 038 0810	MT- GLAZE 22K JA 1/10W
R464	401 014 4145	CARBON 1K5 JA 1/4W	R819	401 038 6515	MT- GLAZE 47K JA 1/10W
R465	401 038 7918	MT- GLAZE 560K JA 1/10W	R821	401 037 5212	MT- GLAZE 100 JA 1/10W
R468	401 025 4220	CARBON 1K8 JA 1/6W	R822	401 037 5618	MT- GLAZE 10K JA 1/10W
R469	401 027 5928	CARBON 68K JA 1/6W	R823	401 039 0413	MT- GLAZE 8.2K JA 1/10W
R471	401 025 1625	CARBON 1K5 JA 1/6W	R824	401 026 4625	CARBON 33K JA 1/6W
R472	401 027 0329	CARBON 47K JA 1/6W	R826	401 037 6714	MT- GLAZE 1.2K JA 1/10W
R473	401 022 1935	CARBON 680 JA 1/4W	R827	401 038 5112	MT- GLAZE 3.9K JA 1/10W
R474	401 009 0927	CARBON 270 JA 1/2W	R828	401 038 3712	MT- GLAZE 33K JA 1/10W
R480	401 027 0329	CARBON 47K JA 1/6W	R831	401 037 5212	MT- GLAZE 100 JA 1/10W
R481	401 064 5305	OXIDE-MT 1.5 JA 2W	R832	401 037 6813	MT- GLAZE 12K JA 1/10W
R491	401 008 3711	CARBON 2.2 JA 1/2W	R833	401 039 0512	MT- GLAZE 82K JA 1/10W
R495	401 025 4923	CARBON 180K JA 1/6W	R834	401 038 6416	MT- GLAZE 4.7K JA 1/10W
R496	401 027 2620	CARBON 5K6 JA 1/6W	R836	401 037 6714	MT- GLAZE 1.2K JA 1/10W
R501	401 020 2053	CARBON 4.7K JA 1/4W	R837	401 038 6515	MT- GLAZE 47K JA 1/10W
R502	401 026 8128	CARBON 4.7 JA 1/6W	R838	401 037 8015	MT- GLAZE 15K JA 1/10W
R505	401 027 5522	CARBON 6K8 JA 1/6W	R839	401 038 6416	MT- GLAZE 4.7K JA 1/10W
R506	401 026 7022	CARBON 3K9 JA 1/6W	R840	401 020 2053	CARBON 4.7K JA 1/4W
R507	401 027 8127	CARBON 82 JA 1/6W	R841	401 038 0810	MT- GLAZE 22K JA 1/10W
R508	401 026 1020	CARBON 2K7 JA 1/6W	R842	401 015 2744	CARBON 1K8 JA 1/4W
R509	401 057 6807	OXIDE-MT 0.68 JA 1W	R843	401 037 5618	MT- GLAZE 10K JA 1/10W
R511	401 062 1200	OXIDE-MT 470 JA 1W	R844	401 037 5618	MT- GLAZE 10K JA 1/10W
R513	401 058 3706	OXIDE-MT 1K JA 1W	R846	401 020 2053	CARBON 4.7K JA 1/4W
R514	401 025 5425	CARBON 2R2 JA 1/4W 26MM	R847	401 012 7049	CARBON 10K JA 1/4W
△ R601	401 008 8627	CARBON 220K JA 1/2W	R848	401 020 2053	CARBON 4.7K JA 1/4W
R602	402 067 7709	WIRE WOUND 3.9 KA 7W	R850	401 038 6416	MT- GLAZE 4.7K JA 1/10W
R611	401 027 2620	CARBON 5K6 JA 1/6W	R852	401 012 5748	CARBON 1K JA 1/4W
R615	401 016 4836	CARBON 22K JA 1/4W	R856	401 016 4836	CARBON 22K JA 1/4W
R617	401 024 7024	CARBON 1K JA 1/6W	R861	401 038 2111	MT- GLAZE 2.7K JA 1/10W
R619	401 016 1538	CARBON 22 JA 1/4W	R862	401 038 0810	MT- GLAZE 22K JA 1/10W
R620	401 007 5815	CARBON 120K JA 1/2W	R863	401 038 0810	MT- GLAZE 22K JA 1/10W
R621	401 007 5815	CARBON 120K JA 1/2W	R864	401 037 5410	MT- GLAZE 1K JA 1/10W
R622	401 014 5241	CARBON 15K JA 1/4W	R865	401 038 6416	MT- GLAZE 4.7K JA 1/10W
R623	401 026 1020	CARBON 2K7 JA 1/6W	R866	401 038 6416	MT- GLAZE 4.7K JA 1/10W
R624	401 069 6208	OXIDE-MT 82 JA 2W	R867	401 038 6416	MT- GLAZE 4.7K JA 1/10W
R625	401 069 1708	OXIDE-MT 68 JA 2W	R868	401 037 6714	MT- GLAZE 1.2K JA 1/10W
R626	401 018 3411	CARBON 3.3K GA 1/4W	R869	401 038 2210	MT- GLAZE 27K JA 1/10W
△ R628	402 000 8602	SOLID 5.6M KA 1/2W	R870	401 038 0810	MT- GLAZE 22K JA 1/10W
△ R629	402 000 8602	SOLID 5.6M KA 1/2W	R871	401 038 6416	MT- GLAZE 4.7K JA 1/10W
R635	401 012 8145	CARBON 100K JA 1/4W	R872	401 038 3712	MT- GLAZE 33K JA 1/10W
R636	RDB4301JPBAN	CARBON 4.3K JA 1/4W	R873	401 038 6416	MT- GLAZE 4.7K JA 1/10W
R637	401 015 4738	CARBON 180K JA 1/4W	R874	401 037 5618	MT- GLAZE 10K JA 1/10W
R638	401 061 4400	OXIDE-MT 33K JA 1W	R875	401 038 7710	MT- GLAZE 5.6K JA 1/10W
R639	401 024 9721	CARBON 12K JA 1/6W	R876	401 037 5618	MT- GLAZE 10K JA 1/10W
R642	401 059 3903	OXIDE-MT 1.5K JA 1W	R877	401 039 0413	MT- GLAZE 8.2K JA 1/10W
R645	402 052 2405	WIRE WOUND 18 KA FH 3W	R878	401 037 7919	MT- GLAZE 1.5K JA 1/10W
R646	401 025 7825	CARBON 2K2 JA 1/6W	R879	401 012 7049	CARBON 10K JA 1/4W
R651	401 012 7049	CARBON 10K JA 1/4W	R880	401 038 6515	MT- GLAZE 47K JA 1/10W
R652	401 019 1941	CARBON 3K9 JA 1/4W	R881	401 038 2210	MT- GLAZE 27K JA 1/10W
R661	401 012 7049	CARBON 10K JA 1/4W	R883	401 020 0841	CARBON 470 JA 1/4W

Ref. No.	Part No.	Description	Ref. No.	Part No.	Description
R884	401 038 2111	MT- GLAZE 2. 7K JA 1/10W	D1910A	610 222 0322	LED HOLDER- G2CA- A
R885	401 038 5112	MT- GLAZE 3. 9K JA 1/10W	D221	407 012 4416	DI ODE 1SS133- T- 77
R887	401 038 5112	MT- GLAZE 3. 9K JA 1/10W	D222	408 007 8607	DI ODE 1N4148
R891	401 038 6416	MT- GLAZE 4. 7K JA 1/10W	D251	407 012 4416	DI ODE 1SS133- T- 77
R892	401 038 6416	MT- GLAZE 4. 7K JA 1/10W	D252	407 012 4416	DI ODE 1SS133- T- 77
R895	401 037 6714	MT- GLAZE 1. 2K JA 1/10W	D253	407 012 4416	DI ODE 1SS133- T- 77
R896	401 038 5112	MT- GLAZE 3. 9K JA 1/10W	D254	407 012 4416	DI ODE 1SS133- T- 77
R897	401 038 5112	MT- GLAZE 3. 9K JA 1/10W	D271	407 053 6407	ZENER DI ODE MTZ5. 1C
R898	401 038 5112	MT- GLAZE 3. 9K JA 1/10W	D351	407 163 9909	ZENER DI ODE UZ- 9. 1BCA
VARIABLE RESISTOR			D352	407 005 7328	DI ODE EMO1Z
VR131	645 006 5422	VR, SEMI, 10K N	D361	407 063 8319	ZENER DI ODE MTZJ11C
VR361	645 006 5422	VR, SEMI, 10K N	D441	407 095 8001	DI ODE ERD07- 15L
VR461	645 006 5606	VR, SEMI, 4. 7K N	D442	407 006 4108	DI ODE ERB44- 04V1
VR501	645 006 5408	VR, SEMI, 100 N	D445	407 012 4416	DI ODE 1SS133- T- 77
VR631	645 006 5514	VR, SEMI, 2. 2K N	D446	407 012 4416	DI ODE 1SS133- T- 77
TRANSFORMER			D447	407 199 8600	ZENER DI ODE UZ- 7. 5BSC
T141	610 037 4522	S COIL	D465	407 012 4416	DI ODE 1SS133- T- 77
△ T431	610 000 1077	DRIVE TRANS	D466	407 164 7805	ZENER DI ODE UZ- 20BCA
△ T471	645 021 2741	TRANS, FLYBACK	D469	407 007 7415	DI ODE EU1
T611	645 007 7494	TRANS, POWER, PULSE	D491	407 007 7415	DI ODE EU1
COIL			D495	408 007 8607	DI ODE 1N4148
L1002	645 001 4550	PEAKING COIL 10UHK	D501	407 005 7328	DI ODE EMO1Z
L1003	645 001 4550	PEAKING COIL 10UHK	D603	407 009 6921	DI ODE RM11C
L1006	645 001 4550	PEAKING COIL 10UHK	D604	407 009 6921	DI ODE RM11C
L1021	645 002 4511	CORE, PIPE	D605	407 009 6921	DI ODE RM11C
L103	645 003 8549	PEAKING COIL	D606	407 009 6921	DI ODE RM11C
L141	645 001 4550	PEAKING COIL 10UHK	D614	408 007 8607	DI ODE 1N4148
L151	645 002 1534	PEAKING COIL 8. 2UHK	△ D615A	407 173 2907	PHOTO COUPLE PC123F2
L152	645 002 1459	PEAKING COIL	D616	408 007 8607	DI ODE 1N4148
L161	645 002 1534	PEAKING COIL 8. 2UHK	D617	407 007 6616	DI ODE ES1
L162	645 002 1534	PEAKING COIL 8. 2UHK	D618	408 007 8607	DI ODE 1N4148
L201	645 003 8518	PEAKING COIL	D619	407 057 8209	ZENER DI ODE RD8. 2EB1
L202	645 003 8518	PEAKING COIL	D631	407 007 7712	DI ODE EU2A
L203	645 003 8518	PEAKING COIL	D633	407 007 7613	DI ODE EU2
L281	645 001 4550	PEAKING COIL 10UHK	D634	407 007 7613	DI ODE EU2
L431	645 008 5628	INDUCTOR, 1U M	D635	407 007 7613	DI ODE EU2
L444	610 000 1046	LINEARITY COIL	D641	407 057 4003	ZENER DI ODE RD6. 8EB1
L444P1	645 008 4058	TERMINAL PLUG	D643	408 007 8607	DI ODE 1N4148
L444P2	645 008 4058	TERMINAL PLUG	D644	408 007 8607	DI ODE 1N4148
L444P3	645 008 4058	TERMINAL PLUG	D645	408 007 8607	DI ODE 1N4148
L444P4	645 008 4058	TERMINAL PLUG	D646	407 053 3109	ZENER DI ODE MTZ12A
L445	610 219 0342	COIL	D649	408 007 8607	DI ODE 1N4148
L445P1	645 008 4058	TERMINAL PLUG	D661	407 005 8612	DI ODE ERA15- 02 26MM
L461	610 031 1367	INDUCTOR	D669	408 007 8607	DI ODE 1N4148
L462	610 000 0261	COIL	D683	408 007 8607	DI ODE 1N4148
L521	645 008 1286	PEAKING COIL	D685	407 057 4003	ZENER DI ODE RD6. 8EB1
△ L601	645 012 3337	LINE FILTER	D805	409 026 8005	IC L5630
L607	610 237 1000	PIPE CORE	D831	407 012 4416	DI ODE 1SS133- T- 77
L608	610 237 1000	PIPE CORE	D861	407 012 4416	DI ODE 1SS133- T- 77
L615	645 002 4511	CORE, PIPE	D862	408 007 8607	DI ODE 1N4148
L801	645 003 8549	PEAKING COIL	D871	408 007 8607	DI ODE 1N4148
L841	645 008 2962	PEAKING COIL 5. 6UH K	D872	407 055 7927	ZENER DI ODE RD3. 6EL
L871	645 008 2962	PEAKING COIL 5. 6UH K	MISCELLANEOUS		
L881	645 001 4543	PEAKING COIL	A101	645 023 4118	TUNER, U/V
DIODE			A101P1	645 008 4058	TERMINAL PLUG
D001	408 007 8607	DIODE 1N4148	A101P2	645 008 4058	TERMINAL PLUG
D002	408 007 8607	DIODE 1N4148	A1901	645 021 1041	REMOCON REC. SPS- 443- 1
D1007	407 063 8319	ZENER DI ODE MTZJ11C	△ F601	423 022 2102	FUSE 250V 4. 0A
D1011	407 063 8319	ZENER DI ODE MTZJ11C	F601- A1	645 000 5077	HOLDER, FUSE
D1015	407 063 8319	ZENER DI ODE MTZJ11C	F601- A2	645 000 5077	HOLDER, FUSE
D1016	407 063 8319	ZENER DI ODE MTZJ11C	JS815	401 037 5014	MT- GLAZE 0. 000 ZA 1/10W
D1019	407 063 8319	ZENER DI ODE MTZJ11C	JS818	401 037 5014	MT- GLAZE 0. 000 ZA 1/10W
D1020	407 063 8319	ZENER DI ODE MTZJ11C	JS819	401 037 5014	MT- GLAZE 0. 000 ZA 1/10W
D1021	407 012 4416	DIODE 1SS133- T- 77	J109	401 037 5014	MT- GLAZE 0. 000 ZA 1/10W
D1031	407 012 4416	DIODE 1SS133- T- 77	J124	401 037 5014	MT- GLAZE 0. 000 ZA 1/10W
D1032	407 012 4416	DIODE 1SS133- T- 77	J126	401 037 5014	MT- GLAZE 0. 000 ZA 1/10W
D135	407 063 8319	ZENER DI ODE MTZJ11C	J222	401 037 5014	MT- GLAZE 0. 000 ZA 1/10W
D1910	407 116 6504	LED SLP- 181B- 51	J836	401 037 5014	MT- GLAZE 0. 000 ZA 1/10W
			KAC- 1	645 008 4058	TERMINAL PLUG
			KAC- 2	645 008 4058	TERMINAL PLUG
			KDY- 1	645 008 4058	TERMINAL PLUG

Ref. No.	Part No.	Description	Ref. No.	Part No.	Description
KDY-3	645 008 4058	TERMINAL PLUG	VARIABLE RESISTOR		
KDY-5	645 008 4058	TERMINAL PLUG	VR701	645 003 5722	VR, SEMI, 4.7K N
KDY-6	645 008 4058	TERMINAL PLUG	VR702	645 003 5647	VR, SEMI, 1K N
KE-1	645 008 4058	TERMINAL PLUG	VR711	645 003 5722	VR, SEMI, 4.7K N
KE-2	645 008 4058	TERMINAL PLUG	VR712	645 003 5647	VR, SEMI, 1K N
KL	645 008 7264	HOUSING PLUG 3P	VR721	645 003 5722	VR, SEMI, 4.7K N
KP	645 008 7288	HOUSING PLUG 5P	MISCELLANEOUS		
KQ	645 008 7264	HOUSING PLUG 3P	K7M	645 008 4058	TERMINAL PLUG
K1001	645 005 5867	21-PIN SOCKET	K7P	645 008 7288	HOUSING PLUG 5P
K1001Z	610 261 2813	MOUNTING BRKT-F2WV	K7Q	645 008 7264	HOUSING PLUG 3P
KR-1	645 008 4058	TERMINAL PLUG	K701	610 233 7990	CRT SOCKET
KR-2	645 008 4058	TERMINAL PLUG	L705	610 078 5946	PIPE CORE
KR-3	645 008 4058	TERMINAL PLUG			
KSC	645 008 4058	TERMINAL PLUG			
PB101	610 264 3879	PWB, CTV F2TC			
△ PS601	408 013 3801	TH PTH451C262BF140M270			
SW1901	610 011 2698	SWITCH, PUSH			
SW1902	610 011 2698	SWITCH, PUSH			
SW1903	610 011 2698	SWITCH, PUSH			
SW1904	610 011 2698	SWITCH, PUSH			
SW1905	610 011 2698	SWITCH, PUSH			
SW1906	610 011 2698	SWITCH, PUSH			
SW501	610 011 2728	SWITCH, LEVER 1P-3T			
△ SW601	645 024 0607	PUSH SW POWER SDDFC3			
TP-A	645 008 4058	TERMINAL PLUG			
TP-D	645 008 4058	TERMINAL PLUG			
TP-E	645 008 4058	TERMINAL PLUG			
X131	421 004 7701	SAW F TSF5344			
X151	645 000 4490	TRAP, CERAMIC (6.5W3)			
X152	1AV4F32B0140	EFC-S5R5MW3AS (5.5B)			
X161	1AV4F31B0020	CERAMIC FILTER (5.5C)			
X162	645 007 7326	CERAMIC FILTER			
X201	645 018 9050	OSC, CRYSTAL 4.43MHZ			
X231	1AV4F32B0110	CERAMIC TRAP (B5740)			
X871	645 018 9593	OSC, CRYSTAL 12MHZ			

1AA0B10H023DB ASSY,PWB,CRT F4ZZV

TRANSISTOR

Q701	405 041 6507	TR 2SC2621-D-RA
Q711	405 041 6507	TR 2SC2621-D-RA
Q721	405 041 6507	TR 2SC2621-D-RA
Q741	406 007 1901	TR JC556A

CAPACITOR

C701	CK1H471KABBJ	CERAMIC	470P K	50V
C711	CK1H471KABBJ	CERAMIC	470P K	50V
C721	CK1H471KABBJ	CERAMIC	470P K	50V
C731	403 077 2728	CERAMIC	1000P P	2K

RESISTOR

R701	401 018 2840	CARBON	330 JA	1/4W
R702	401 017 1844	CARBON	2K7 JA	1/4W
R703	401 012 5748	CARBON	1K JA	1/4W
R704	401 065 4604	OXIDE-MT	12K JA	2W
R705	401 009 6622	CARBON	3.3K JA	1/2W
R711	401 018 2840	CARBON	330 JA	1/4W
R712	401 017 1844	CARBON	2K7 JA	1/4W
R713	401 016 3849	CARBON	2.2K JA	1/4W
R714	401 065 4604	OXIDE-MT	12K JA	2W
R715	401 009 6622	CARBON	3.3K JA	1/2W
R721	401 018 2840	CARBON	330 JA	1/4W
R722	401 017 1844	CARBON	2K7 JA	1/4W
R723	401 015 2744	CARBON	1K8 JA	1/4W
R724	401 065 4604	OXIDE-MT	12K JA	2W
R725	401 009 6622	CARBON	3.3K JA	1/2W
R727	401 020 0841	CARBON	470 JA	1/4W
R741	401 020 2053	CARBON	4.7K JA	1/4W
R742	401 018 3857	CARBON	3K3 JA	1/4W
R744	401 018 2840	CARBON	330 JA	1/4W

Ref. No.	Part No.	Description	Ref. No.	Part No.	Description

Ref. No.	Part No.	Description	Ref. No.	Part No.	Description

NOTES:
 1. RESISTORS SPECIFIED WITH RESISTANCE VALUE ARE "1/6W".
 2. RESISTORS SPECIFIED WITH TYPE OF RESISTOR, TOLERANCE AND RESISTANCE VALUE ARE "1/4W".
 3. ALL CAPACITORS ARE 50V UNLESS OTHERWISE NOTED.
 4. CAPACITORS SPECIFIED WITH TYPE OF CAPACITOR, TOLERANCE AND RESISTANCE VALUE ARE "1/4W".

8. LIST OF REPLACEABLE DIODES

M (72D00205)	1S1516, 1S1513, GMA01
R (72D00119)	1S1555, 1S2076, 1S2473, DS442, 1N4148
AA (72D00182)	1S1555, 1S2076, 1S2473, DS442, 1N4148, 1S1516, 1S1513, GMA01
P (72D00021)	1S1555, 1S2076, 1S2473, DS442, 1N4148

9. LIST OF REPLACEABLE TRANSISTORS

AD (72Z01483)	2SC236	2SC454A	2SC1815	2SC1198B
AE (72Z01020)	E.F.G.	R.Q.P.	O.V.G.R.	O.R.S.
AB (72Z01481)	2SA608	2SA644A	2SA1015	2SA933S
AC (72Z01482)	F	R	Y	Q.R.
AD (72Z01483)	E.F.	Q.R.	O.V.	R



MODEL DIFFERENCES

CE28MT2-EH	CE28MT2-EZ
MAIN UNIT	MAIN UNIT
1AA0B10H023DA	1AA0B10H023GA
R842 CARBON 3K9	R842 CARBON 1K8

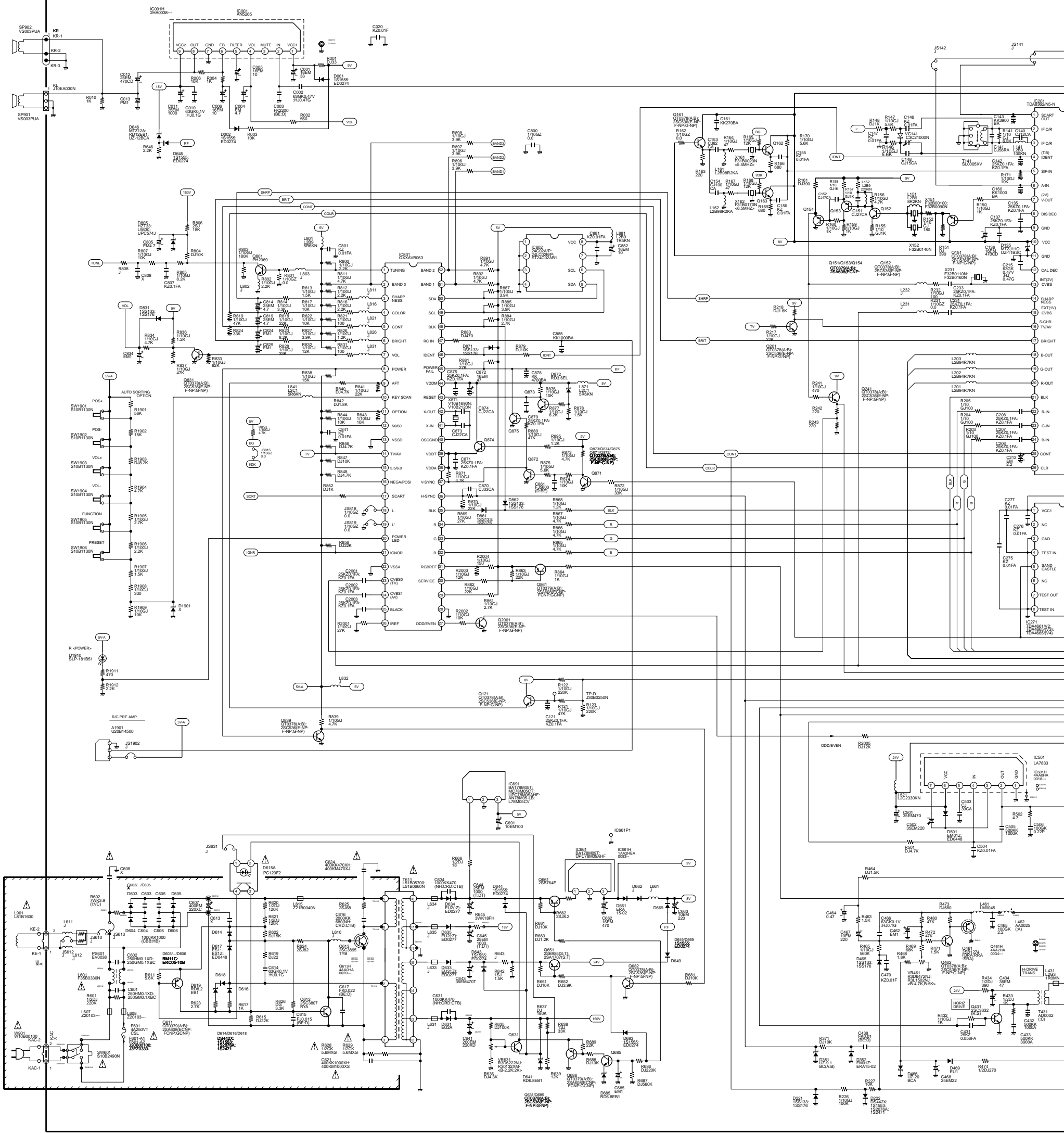

COLOUR TELEVISION

SANYO

CHASSIS SERIES **EC5**

MODEL NUMBER **CE28MT2-EH**
CE28MT2-EZ

SERVICE REF. NO. **CE28MT2-EH-01**
CE28MT2-EZ-01

The service Precaution:
 The area enclosed by this line () is directly connected with AC mains voltage. When servicing the area, connect an isolating transformer between TV receiver and AC line to eliminate hazard of electric shock.

Product safety notice:
 Product safety should be considered when a component replacement is made in any area of a receiver. Components indicated by a mark Δ in this circuit diagram show components whose values have special significance to product safety. It is particularly recommended that only parts specified on the part service manual be used for components replacement pointed out by the mark.

PRECAUZIONE DI SERVIZIO
 L'area inclusa in questa linea () è collegata direttamente con la tensione della rete CA quando si serve l'area collegare un trasformatore isolante tra il ricevitore TV e la linea CA per eliminare il pericolo di scossa elettrica.

NOTIZIE SULLA SICUREZZA DI FUNZIONAMENTO
 Ogni sostituzione di componenti va fatta tenendo conto della sicurezza di funzionamento. I componenti indicati solo schema con il simbolo Δ hanno particolare importanza per il sicuro funzionamento del TV. I suddetti componenti devono essere sostituiti esclusivamente con quelli indicati nell'elenco.

Note sul diagramma di circuito :
 1. Tutte i valori di resistenza sono in ohm, K=1,000, M=1,000,000.
 2. Tutte le resistenze nominali watt sono di 1/6 a meno che sia specificato altrimenti.
 3. Eccetto per i condensatori elettrolitici, tutti i valori di capacitance di meno di sono espressi in μ F, e di più di 1 sono in pF. I valori di capacitance elettrolitici sono in μ F.
 4. Tutti i valori di capacitance nominali sono di 50V a meno che sia indicato altrimenti.
 5. Tutti i valori di induttanza sono in μ H.
 6. I valori letti del voltaggio presi con un "VTVM" proveni gono dal punto indicato sulla massa del chassis, i valori di voltaggio presi usando un segnale di barre colore sono con tutti i controlli alle loro posizioni normali ed il commutatore AFC in posizione "OFF". Il voltaggio puo variare con l'intensita del segnale.

7. Le forme di onda furono prese con il segnale di barre colore e i controlli regolati oppure le forme di onda di immagine normale furono prese usando un oscillatore a larga banda ed una sonda bassa capacitance.
 8. Rispetto a quando indicato su questo schema possono essere state introdotte delle modifiche.
 9. I diodi 1S1555 possono essere sostituiti con 1S2473, 1S2076 oppure DS472 a meno che sia specificato altrimenti.
 I transistori possono essere sostituiti con 2SC536(Q,R,S), 2SC1740(Q,R,S), 2SC945A(Q,R,P) oppure 2SC1815(G,O,Y) a meno che sia specificato altrimenti.
 Il transistor 2SA608(E,F) puo essere sostituito con 2SA933(Q,R), 2SA564(QA,RA), oppure 2SA1015(O,Y) a meno che sia specificato altrimenti.

Circuit diagram notes :
 1. All resistance values are in ohms, K=1,000, M=1,000,000.
 2. All resistance rated wattages are 1/6W unless otherwise noted.
 3. Excepting electrolytic capacitors, all capacitance values of less than 1 are expressed in μ F and more than 1 are pF.
 4. All capacitance rated voltages are 50V unless otherwise noted.
 5. All inductance values are in μ H.
 6. Voltage readings taken a digital voltmeter are from point indicated chassis ground. Voltage readings taken by using a colour bar signal are with all controls at normal position. Some voltages may vary with signal strength.
 7. Waveforms were taken with colour bar and controls adjusted for normal picture. Waveforms were taken by using a wide band oscilloscope and a low capacity probe.

Main/CRT Board /Pannello Principale/Cinescopio
Circuit side/Lato del Circuito

